

# LVSM-140 Technical Information

Motor Parameters			LVSM-140-01				LVSM-140-02				LVSM-140-03				
Winding Type	Symbols	Units	A		B		A		B		A		B		
PERFORMANCE	DC Bus Voltage	V <sub>dc</sub>	24	48	24	48	24	48	24	48	24	48	24	48	
	Rated Power	P <sub>r</sub>	1.24	2.46	1.69	3.03	2.34	4.05	2.99	4.56	2.85	4.96	4.05	5.24	
	Stall Torque	T <sub>s</sub>	7.1	7.1	7.1	7.1	12.8	12.8	12.2	12.2	17.6	17.6	16.4	16.4	
	Rated Torque	T <sub>r</sub>	6.7	6.2	6.6	5.7	11.9	10.0	11.3	8.3	16.5	13.6	15.2	9.4	
	Peak Torque	T <sub>p</sub>	25.3	25.3	25.3	25.3	50.5	50.5	50.6	50.6	76.0	76.0	75.9	75.9	
	Rated Speed	N <sub>r</sub>	rpm	1775	3800	2450	5100	1875	3875	2525	5250	1650	3475	2550	5300
	No-Load Speed <sup>(2)</sup>	N <sub>no-load</sub>	rpm	2214	4428	2952	5904	2214	4444	2952	5904	1967	3934	2952	5904
	Torque Constant	K <sub>t</sub>	Nm/A <sub>rms</sub>	0.13	0.13	0.09	0.09	0.13	0.13	0.09	0.09	0.14	0.14	0.09	0.09
	Voltage Constant <sup>(2)</sup>	K <sub>v</sub>	V <sub>rms</sub> /krpm	7.67	7.67	5.75	5.75	7.67	7.64	5.75	5.75	8.63	8.63	5.75	5.75
	ELECTRICAL	Stall Current	I <sub>s</sub>	56.5	56.5	75.1	75.1	101.0	101.0	128.3	128.3	123.5	123.5	172.7	172.7
Rated Current		I <sub>r</sub>	54.4	50.5	71.5	62.4	96.2	81.9	122.2	91.7	117.7	98.8	164.5	105.3	
Peak Current		I <sub>p</sub>	209	209	278	278	417	417	557	557	558	558	836	836	
Line Resistance <sup>(2)</sup>		R <sub>LL</sub>	mOhm	16 (±20%)	16 (±20%)	9 (±20%)	9 (±20%)	6 (±20%)	6 (±20%)	3 (±20%)	3 (±20%)	4 (±20%)	4 (±20%)	2 (±20%)	2 (±20%)
Line Inductance <sup>(2)</sup>		L <sub>LL</sub>	mH	0.06	0.06 (±30%)	0.04 (±30%)	0.04 (±30%)	0.04 (±30%)	0.04 (±30%)	0.02 (±30%)	0.02 (±30%)	0.03 (±30%)	0.03 (±30%)	0.01 (±30%)	0.01 (±30%)
Inertia (without brake)		J	kg.cm <sup>2</sup>	19.5	19.5	19.5	19.5	37.5	37.5	37.5	37.5	55.5	55.5	55.5	55.5
Weight (without brake)		W	kg	10.62	10.36	10.36	10.36	15.31	15.31	15.28	15.28	20.64	20.64	20.64	20.64
Thermal Resistance <sup>(2)</sup>		K <sub>therm</sub>	C°/W	1.12	0.77	0.98	0.60	0.87	0.54	0.81	0.42	0.77	0.47	0.59	0.32
Mech. Time Constant		K <sub>mech</sub>	ms	2.45	2.43	2.47	2.46	1.59	1.60	1.32	1.32	1.36	1.36	1.37	1.37
Motor Constant		K <sub>m</sub>	Nm/VW	0.83	0.90	0.84	0.96	1.45	1.71	1.60	2.13	1.91	2.28	1.91	2.98
FEEDBACK	Pole Number	n	10												
	Input Voltage	V <sub>rms</sub>	4												
	Frequency	kHz	5												
	Input Current	mA	26												
	Transformation Ratio		0.5±10%												
	Null Voltage	mV <sub>max</sub>	30												
	Phase Shift	Deg	-8°±2°												

1. All performance and electrical specifications are obtained at 25°C ambient and may change ±10%. 2. Rated data with reference aluminum plate 300mm x 408mm x 12mm (maximum winding temperature is 120°C). 3. Higher torque and speed values as well as dimensions on request.

# LVSM-140 Torque-Speed Curves

Tr: Rated Torque — @Tr 24V - - - @Tr 48V  
 Tp: Peak Torque — @Tp 24V - - - @Tp 48V

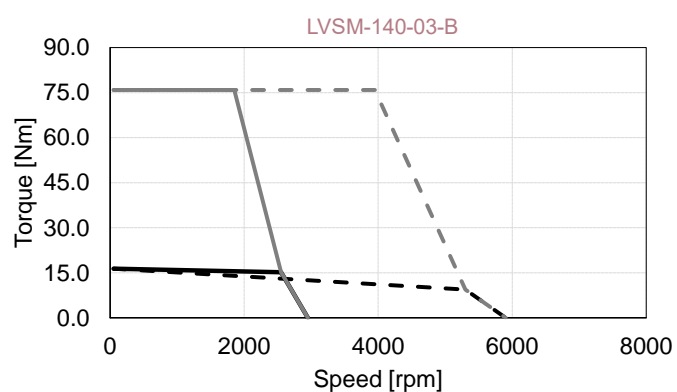
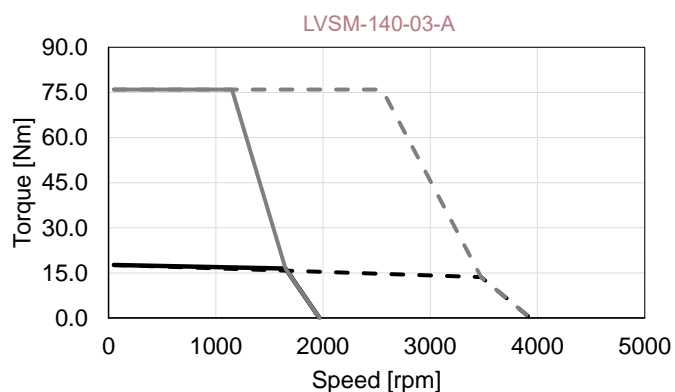
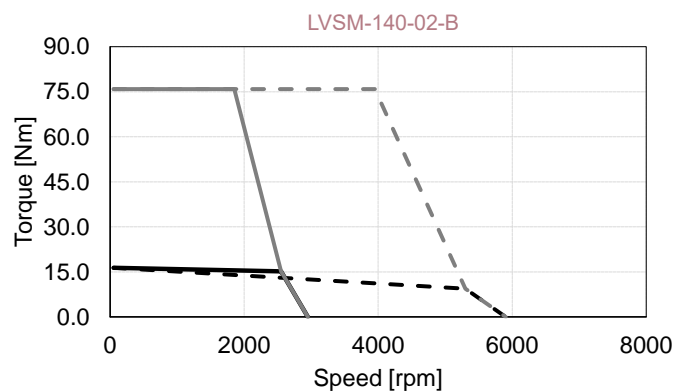
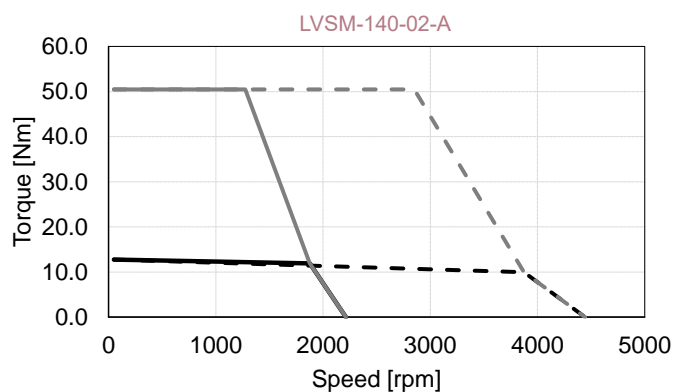
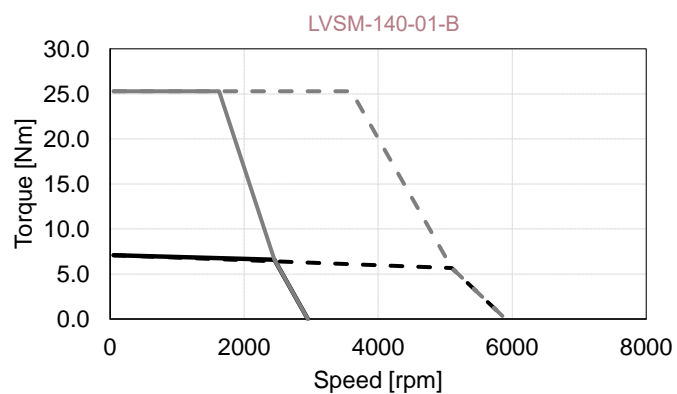
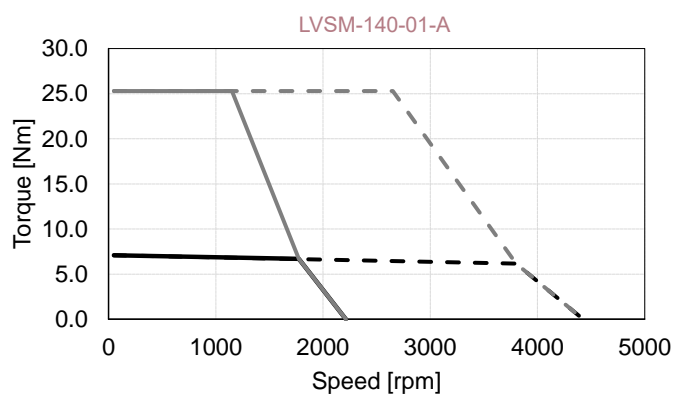

# LVSM-140 Outline Drawing

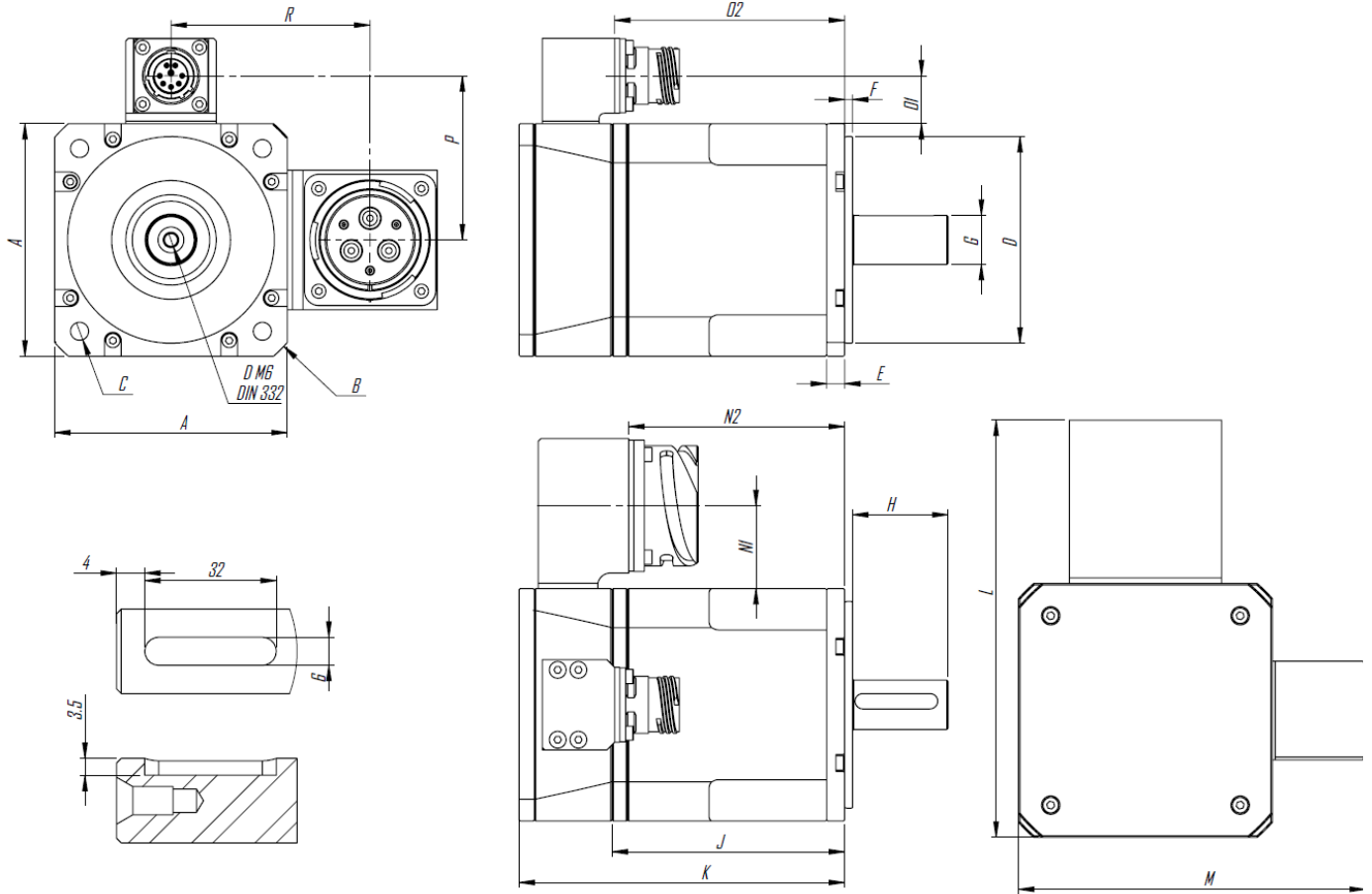

Symbols	Units	Frensiz			Frenli		
		LVSM-140-01	LVSM-140-02	LVSM-140-03	LVSM-140-01	LVSM-140-02	LVSM-140-03
A	mm	140	140	140	140	140	140
B	mm	185	185	185	185	185	185
C	mm	Ø11 on Ø165	Ø11 on Ø165	Ø11 on Ø165	Ø11 on Ø165	Ø11 on Ø165	Ø11 on Ø165
D	mm	Ø130	Ø130	Ø130	Ø130	Ø130	Ø130
E	mm	12	12	12	12	12	12
F	mm	3.5	3.5	3.5	3.5	3.5	3.5
G	mm	Ø32	Ø32	Ø32	Ø32	Ø32	Ø32
J	mm	110	158	206	110	158	206
K	mm	157	205	253	212	260	308
L	mm	208	208	208	208	208	208
M	mm	172	172	172	172	172	172
N1	mm	36	36	36	36	36	36
N2	mm	104	152	200	159	207	255
O1	mm	19	19	19	19	19	19
O2	mm	111	159	207	167	215	263
P	mm	88	88	88	88	88	88
R	mm	106	106	106	106	106	106

# Power - Signal Connector

Power Connector (CB2-36-3-PC-FM)

Pin	Function	Description
A	GND	GND
B	B	Phase B
C	-	-
D	C	Phase C
E	-	-
F	A	Phase A

Signal Connector (D38999/20WC8PN)

Pin	Function	Description
A	R1	Ref (+)
B	R2	Ref (-)
C	S1	Cos (+)
D	S3	Cos (-)
E	S2	Sin (+)
F	S4	Sin (-)
G	NTC	Thermal Sensor
H	NTC	Thermal Sensor