

Motor Parameters		Symbols	Units	WTRM-240-L-034		WTRM-240-L-070		WTRM-240-L-140	
PERFORMANCE	DC Bus Voltage	V_{DC}	V	24	48	24	48	24	48
	Rated Torque	T_r	Nm	54.3		112.1		165.2	
	Peak Torque	T_{peak}	Nm	79.8		164.4		218.6	
	Rated Speed	N_r	rpm	90	225	45	130	30	90
	No-Load Speed	$N_{no-load}$	rpm	155	315	90	185	60	125
	Torque Constant	K_t	Nm/A	1.7		2.77		4.35	
	Voltage Constant	K_v	V/rpm	0.147		0.241		0.373	
	Max. Cogging Torque	T_{cog}	%			<1			
	Torque Ripple	T_{ripple}	%			<1			
	Number of Pole	$2p$	--			32			
ELECTRICAL	Rated Current	I_r	A_{rms}	32		40.4		38	
	Peak Current	I_{peak}	A_{rms}	48		60.6		50.7	
	Line Resistance	$R_{LL}@25^{\circ}C$	Ohm	0.22 ($\pm 20\%$)		0.22 ($\pm 20\%$)		0.23 ($\pm 20\%$)	
	Line Inductance	$L_{LL}@60Hz$	mH	1.31 ($\pm 30\%$)		1.63 ($\pm 30\%$)		1.91 ($\pm 30\%$)	
MECHANICAL & THERMAL	Total Weight	W_{total}	kg	8.41		14.93		28.06	
	Mech. Time Constant	K_{mech}	ms	1.68		1.26		1.09	
	Thermal Resistance ⁽²⁾	R_{th}	$^{\circ}C/W$	0.086		0.046		0.025	
	Inertia	J	$kg.m^2$	0.0182		0.0365		0.0732	
	Water Inlet Temp.	T_w	$^{\circ}C$			20			
	Water Temp. Diff. Between Inlet-Outlet	ΔT_w	$^{\circ}C$	2.3		2.6		1.5	
	Min. Water Volumetric Flow Rate	q_w	l/min	3.4		4.8		7.8	
	Pressure Drop for q_w	ΔP_w	bar	0.0309		0.0313		0.0576	
	Environment Temp.	T_{env}	$^{\circ}C$			20			
	Rotor ID	R_{ID}	mm			158			

Motor Parameters		Symbols	Units	WTRM-240-H-035		WTRM-240-H-070		WTRM-240-H-140	
PERFORMANCE	DC Bus Voltage	V_{DC}	V	310	560	310	560	310	560
	Rated Torque	T_r	Nm	68.1		138.4		274.1	
	Peak Torque	T_{peak}	Nm	115.5		233.7		463.7	
	Rated Speed	N_r	rpm	220	440	205	405	140	285
	No-Load Speed	$N_{no-load}$	rpm	340	630	310	560	215	395
	Torque Constant	K_t	Nm/A	10.09		11.3		15.89	
	Voltage Constant	K_v	V/rpm	0.88		0.987		1.387	
	Max. Cogging Torque	T_{cog}	%			<1			
	Torque Ripple	T_{ripple}	%			<1			
	Number of Pole	$2p$	--			32			
ELECTRICAL	Rated Current	I_r	A_{rms}	6.8		12.3		17.3	
	Peak Current	I_{peak}	A_{rms}	12.2		22.1		31.1	
	Line Resistance	$R_{LL}@25^{\circ}C$	Ohm	7.88 ($\pm 20\%$)		3.76 ($\pm 20\%$)		3.27 ($\pm 20\%$)	
	Line Inductance	$L_{LL}@60Hz$	mH	47.2 ($\pm 30\%$)		27.7 ($\pm 30\%$)		26.3 ($\pm 30\%$)	
MECHANICAL & THERMAL	Total Weight	W_{total}	kg	8.41		14.93		28.06	
	Mech. Time Constant	K_{mech}	ms	1.69		1.29		1.14	
	Thermal Resistance ⁽²⁾	R_{th}	$^{\circ}C/W$	0.086		0.046		0.025	
	Inertia	J	$kg.m^2$	0.0182		0.0365		0.0732	
	Water Inlet Temp.	T_w	$^{\circ}C$			20			
	Water Temp. Diff. Between Inlet-Outlet	ΔT_w	$^{\circ}C$	3.7		4.1		4.4	
	Min. Water Volumetric Flow Rate	q_w	l/min	3.4		4.8		7.8	
	Pressure Drop for q_w	ΔP_w	bar	0.0309		0.0313		0.0576	
	Environment Temp.	T_{env}	$^{\circ}C$			20			
	Rotor ID	R_{ID}	mm			158			

1. All performance and electrical specifications are obtained at 25°C ambient and may change $\pm 10\%$. 2. Maximum coil temperature is 130°C. 3. Higher torque and speed values as well as dimensions on request.

WTRM-240-(L/H)-Torque-Speed Curves

Tr: Rated Torque
Tp: Peak Torque

— @Tr 24V - - - @Tr 48V
— @Tp 24V - - - @Tp 48V

— @Tr 310V - - - @Tr 560V
— @Tp 310V - - - @Tp 560V

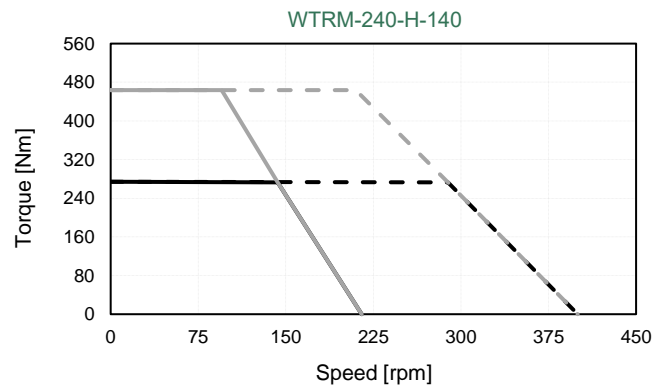
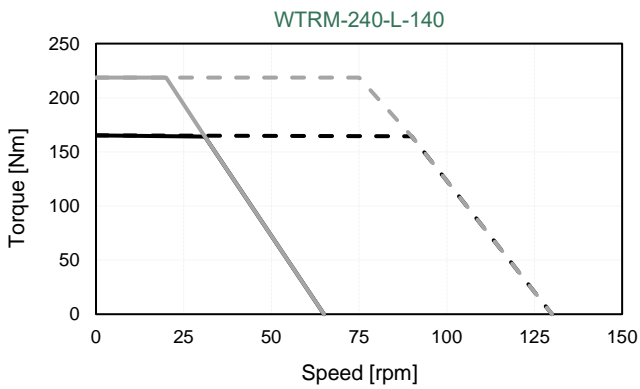
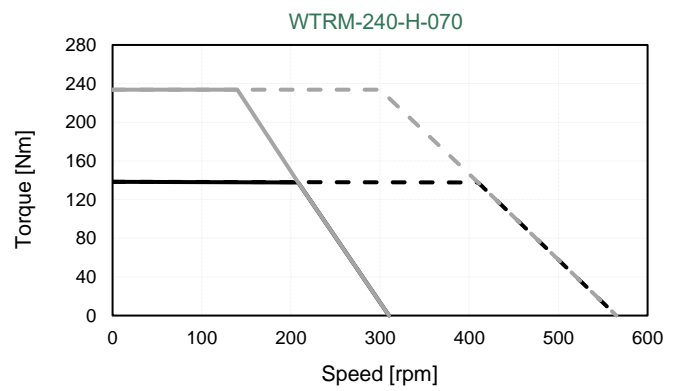
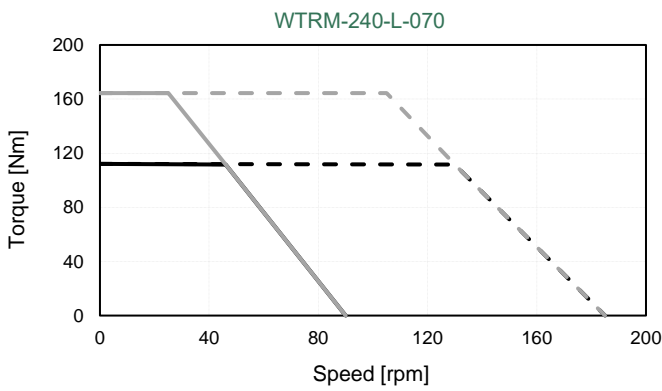
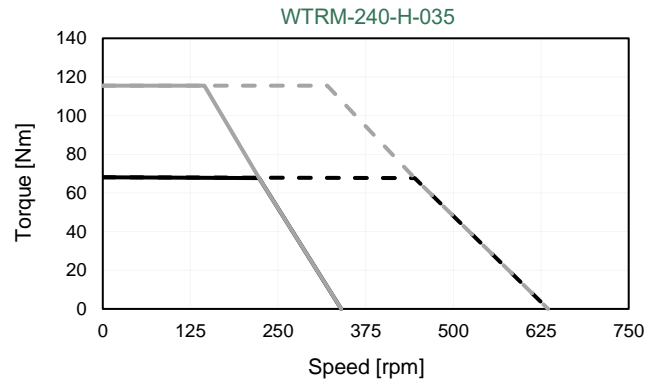
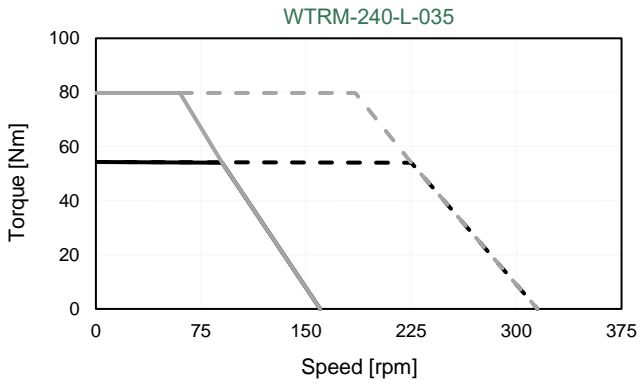

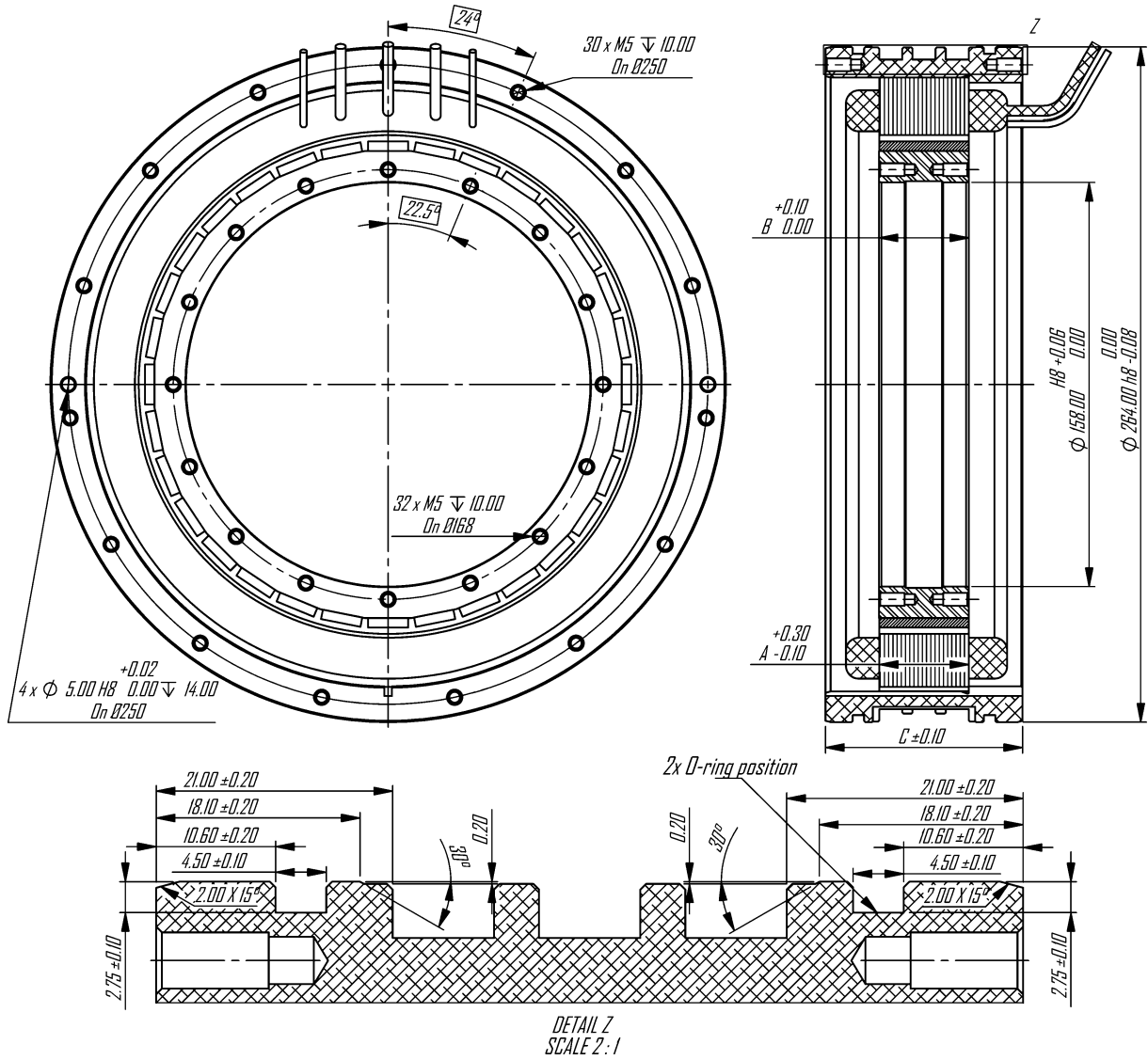

Model	A (mm)	B (mm)	C (mm)
WTRM-(L/H)-240-035	35	35.1	77
WTRM-(L/H)-240-070	70	70.2	112
WTRM-(L/H)-240-140	140	140.4	182

All dimensions in mm

Notes:

MOTOR LEADS:

WTRM-240-L: #8 AWG Teflon® insulated, 500 mm (optional) length, 1-Red, 1-White, 1-Black.
 WTRM-240-H: #12 AWG Teflon® insulated, 500 mm (optional) length, 1-Red, 1-White, 1-Black.

THERMISTOR LEADS:

#26 AWG Teflon® insulated, 500 mm (optional) length, 2-Brown or Blue.