

Motor Parameters		Symbols	Units	WTRM-230-L-030		WTRM-230-L-060		WTRM-230-L-120	
PERFORMANCE	DC Bus Voltage	V_{DC}	V	24	48	24	48	24	48
	Rated Torque	T_r	Nm	45.8		92.5		138.6	
	Peak Torque	T_{peak}	Nm	67.5		136		183.9	
	Rated Speed	N_r	rpm	80	215	45	135	30	90
	No-Load Speed	$N_{no-load}$	rpm	155	315	95	200	60	125
	Torque Constant	K_t	Nm/A	1.7		2.61		4.2	
	Voltage Constant	K_v	V/rpm	0.146		0.225		0.36	
	Max. Cogging Torque	T_{cog}	%			<1			
	Torque Ripple	T_{ripple}	%			<1			
ELECTRICAL	Number of Pole	$2p$	--			32			
	Rated Current	I_r	A_{rms}	27		35.4		33	
	Peak Current	I_{peak}	A_{rms}	40.5		53.1		44	
	Line Resistance	$R_{LL}@25^{\circ}C$	Ohm	0.32 ($\pm 20\%$)		0.26 ($\pm 20\%$)		0.28 ($\pm 20\%$)	
	Line Inductance	$L_{LL}@60Hz$	mH	1.64 ($\pm 30\%$)		1.79 ($\pm 30\%$)		2.15 ($\pm 30\%$)	
MECHANICAL & THERMAL	Total Weight	W_{total}	kg	7.22		12.74		23.61	
	Mech. Time Constant	K_{mech}	ms	1.70		1.23		1.03	
	Thermal Resistance ⁽²⁾	R_{th}	$^{\circ}C/W$	0.100		0.054		0.029	
	Inertia	J	$kg.m^2$	0.0130		0.0262		0.0526	
	Water Inlet Temp.	T_w	$^{\circ}C$			20			
	Water Temp. Diff. Between Inlet-Outlet	ΔT_w	$^{\circ}C$	2.3		2.5		1.5	
	Min. Water Volumetric Flow Rate	q_w	l/min	3.3		4.6		7.0	
	Pressure Drop for q_w	ΔP_w	bar	0.0286		0.0362		0.0466	
	Environment Temp.	T_{env}	$^{\circ}C$			20			
Rotor ID	R_{ID}	mm			148				

Motor Parameters		Symbols	Units	WTRM-230-H-030		WTRM-230-H-060		WTRM-230-H-120	
PERFORMANCE	DC Bus Voltage	V_{DC}	V	310	560	310	560	310	560
	Rated Torque	T_r	Nm	56.6		114.1		225.1	
	Peak Torque	T_{peak}	Nm	95.8		192.8		384.7	
	Rated Speed	N_r	rpm	215	440	200	400	155	315
	No-Load Speed	$N_{no-load}$	rpm	350	640	305	560	240	440
	Torque Constant	K_t	Nm/A	9.84		11.41		14.52	
	Voltage Constant	K_v	V/rpm	0.855		0.99		1.26	
	Max. Cogging Torque	T_{cog}	%			<1			
	Torque Ripple	T_{ripple}	%			<1			
ELECTRICAL	Number of Pole	$2p$	--			32			
	Rated Current	I_r	A_{rms}	5.8		10		15.5	
	Peak Current	I_{peak}	A_{rms}	10.4		18		27.9	
	Line Resistance	$R_{LL}@25^{\circ}C$	Ohm	10.48 ($\pm 20\%$)		5.26 ($\pm 20\%$)		3.62 ($\pm 20\%$)	
	Line Inductance	$L_{LL}@60Hz$	mH	56.5 ($\pm 30\%$)		34.9 ($\pm 30\%$)		26.9 ($\pm 30\%$)	
MECHANICAL & THERMAL	Total Weight	W_{total}	kg	7.22		12.74		23.61	
	Mech. Time Constant	K_{mech}	ms	1.70		1.28		1.09	
	Thermal Resistance ⁽²⁾	R_{th}	$^{\circ}C/W$	0.100		0.054		0.029	
	Inertia	J	$kg.m^2$	0.0130		0.0262		0.0526	
	Water Inlet Temp.	T_w	$^{\circ}C$			20			
	Water Temp. Diff. Between Inlet-Outlet	ΔT_w	$^{\circ}C$	3.6		4.0		4.4	
	Min. Water Volumetric Flow Rate	q_w	l/min	3.3		4.6		7.0	
	Pressure Drop for q_w	ΔP_w	bar	0.0286		0.0362		0.0466	
	Environment Temp.	T_{env}	$^{\circ}C$			20			
Rotor ID	R_{ID}	mm			148				

1. All performance and electrical specifications are obtained at 25°C ambient and may change $\pm 10\%$. 2. Maximum coil temperature is 130°C. 3. Higher torque and speed values as well as dimensions on request.

WTRM-230-(L/H)-Torque-Speed Curves

Tr: Rated Torque
Tp: Peak Torque

— @Tr 24V - - - @Tr 48V
— @Tp 24V - - - @Tp 48V

— @Tr 310V - - - @Tr 560V
— @Tp 310V - - - @Tp 560V

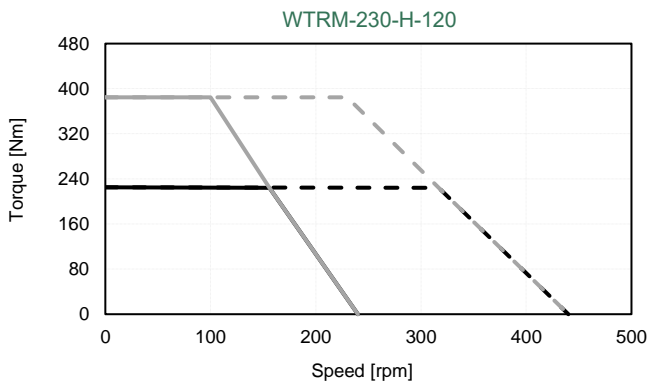
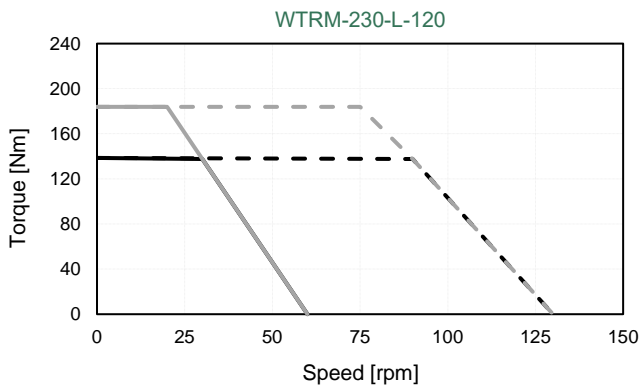
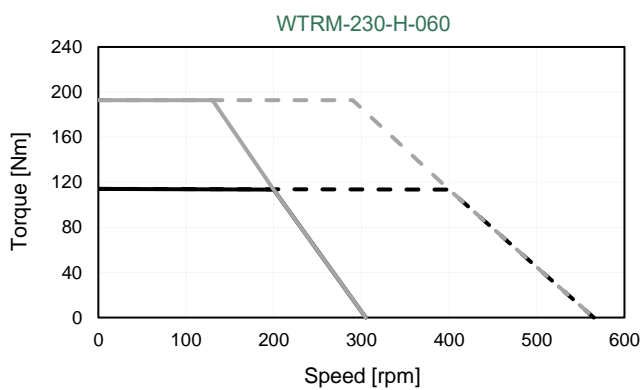
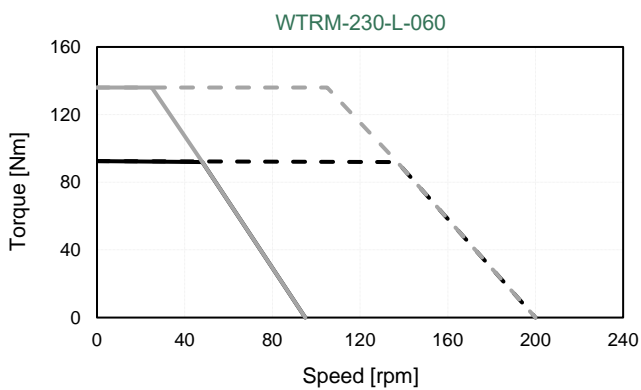
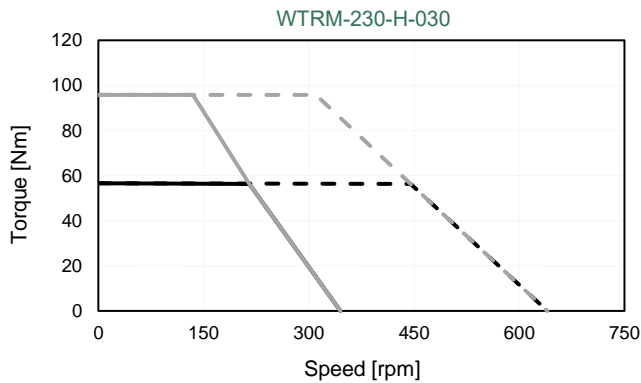
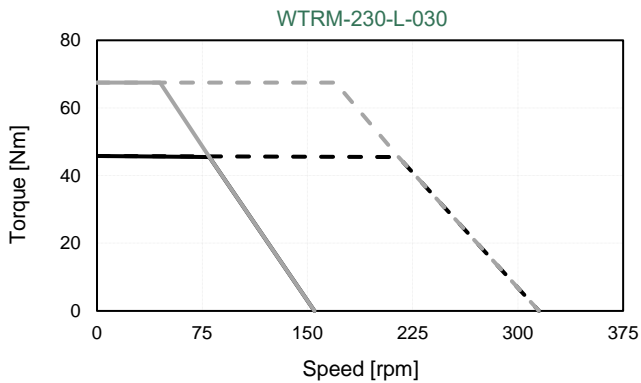

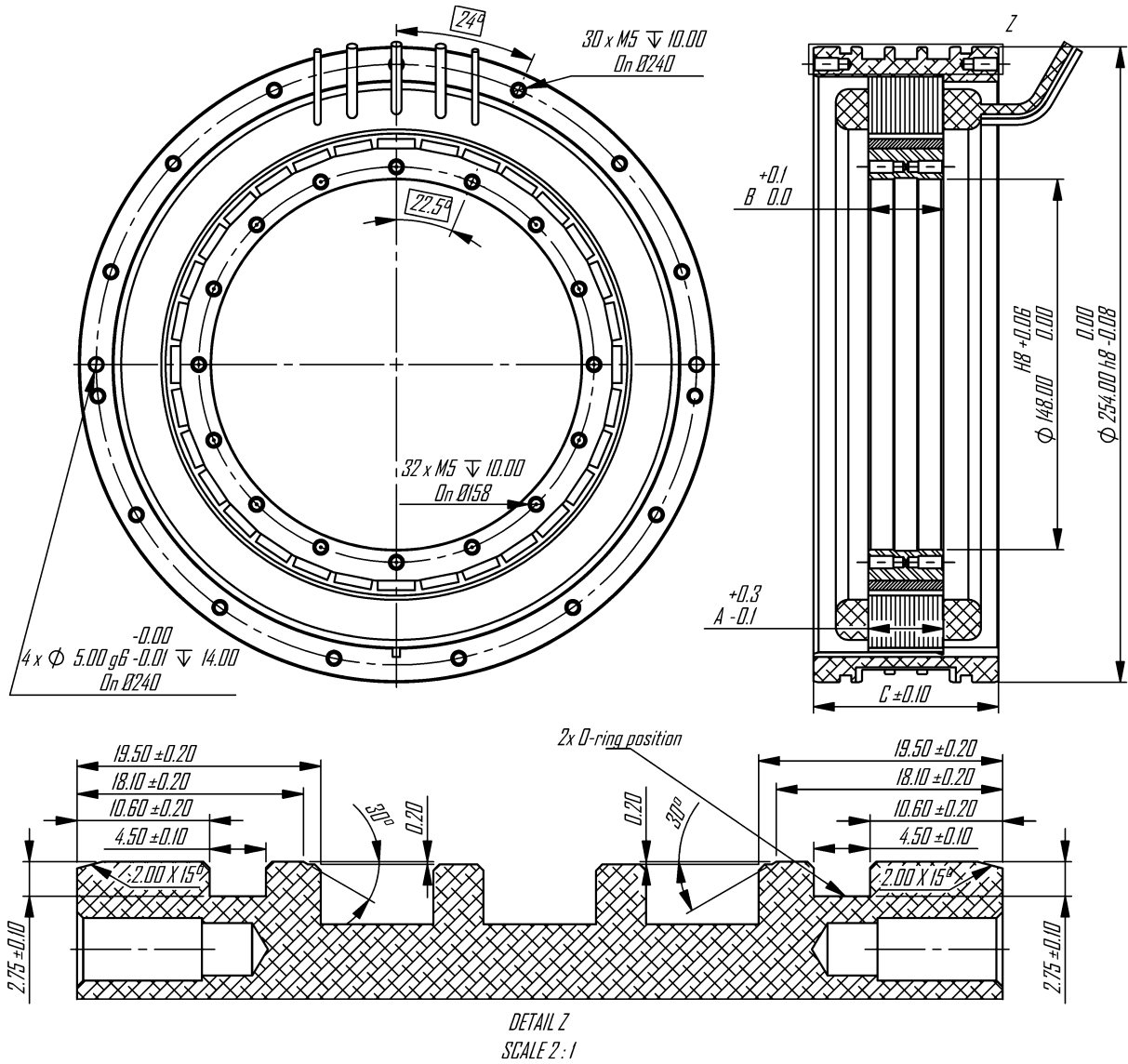

Model	A (mm)	B (mm)	C (mm)
WTRM-(L/H)-230-030	30	30.1	74
WTRM-(L/H)-230-060	60	60.2	104
WTRM-(L/H)-230-120	120	120.4	164

All dimensions in mm

Notes:

MOTOR LEADS:

WTRM-230-L: #9 AWG Teflon® insulated, 500 mm (optional) length, 1-Red, 1-White, 1-Black.
 WTRM-230-H: #12 AWG Teflon® insulated, 500 mm (optional) length, 1-Red, 1-White, 1-Black.

THERMISTOR LEADS:

#26 AWG Teflon® insulated, 500 mm (optional) length, 2-Brown or Blue.